

Rev. 1.0.0
Item no. QSG-PLM+SERIES

PLM+ SERIES

Powered Loudspeaker Management™ System



PLM 20K44
PLM 12K44

1. Important safety instructions

Before using the device, be sure to carefully read the Safety Instructions. Keep this document with the device at all times.

1. Read these instructions.
2. Keep these instructions
3. Heed all warnings.
4. Follow all instructions.
5. Do not use this apparatus near water.
6. Clean only with a dry cloth.
7. Do not block any ventilation openings. Install in accordance with the manufacturer's instructions.
8. Do not install near any heat sources such as radiators, heat registers, stoves, or other apparatus (including amplifiers) that produce heat.
9. Do not defeat the safety purpose of the polarized or grounding-type plug. A polarized plug has two blades with one wider than the other. A grounding-type plug has two blades and a third grounding prong. The wide blade or the third prong is provided for your safety. If the provided plug does not fit into your outlet, consult an electrician for replacement of the obsolete outlet.
10. Protect the power cord from being walked on or pinched, particularly at plugs, convenience receptacles, and the point where they exit from the apparatus.
11. Only use attachments/accessories specified by the manufacturer.
12. Use only with a cart, stand, tripod, bracket, or table specified by the manufacturer, or sold with the apparatus. When a cart is used, use caution when moving the cart/apparatus combination to avoid injury from tip-over.
13. Unplug this apparatus during lightning storms or when unused for long periods of time.
14. Refer all servicing to qualified service personnel. Servicing is required when the apparatus has been damaged in any way, such as power-supply cord or plug is damaged, liquid has been spilled or objects have fallen into the apparatus, the apparatus has been exposed to rain or moisture, does not operate normally, or has been dropped.
15. Use the mains plug to disconnect the apparatus from the mains.
16. **WARNING:** To reduce the risk of fire or electric shock, do not expose this apparatus to rain or moisture.
17. Do not expose this equipment to dripping or splashing and ensure that no objects filled with liquids, such as vases, are placed on the equipment.
18. The mains plug of the power supply cord shall remain readily operable.
19. Do not connect the unit's output to any other voltage source such as battery, mains source, or power supply, regardless of whether the unit is turned on or off.
20. Do not remove the top (or bottom) cover. Removal of the cover will expose hazardous voltages. There are no user serviceable parts inside and removal may void the warranty.
21. An experienced user shall always supervise this professional audio equipment, especially if inexperienced adults or minors are using the equipment.
22. The US National Differences clause 16.3 requires that network cables must be flame rated VW-1.



2. Approvals



This equipment conforms to the requirements of the EMC Directive 2004/108/EC and the requirements of the Low Voltage Directive 2006/95/EC.

Standards applied: EMC Emission EN55103-1, E3
EMC Immunity EN55103-2, E3, with S/N below 1% at normal operation level.
Electrical Safety EN60065, Class I



This equipment is tested and listed according to the U.S. safety standard ANSI/UL 60065 and Canadian safety standard CSA C22.2 NO. 60065. Intertek made the tests and they are a Nationally Recognized Testing Laboratory (NRTL).

3. Warnings

3.1. Explanation of warning symbols



The lightning bolt triangle is used to alert the user to the presence of un-insulated "dangerous voltages" within the unit's chassis that may be of sufficient magnitude to constitute a risk of electric shock to humans.



The exclamation point triangle is used to alert the user to presence of important operating and service instructions in the literature accompanying the product.

3.2. Warnings

To prevent electric shock do not remove top or bottom covers. No user serviceable parts inside, refer servicing to qualified service personnel.

Français: À prévenir le choc électrique n'enlevez pas les couvercles. Il n'y a pas des parties serviceable à l'intérieur, tous reparations doit être faire par personnel qualifié seulement.



 To completely disconnect this equipment from the AC mains, disconnect the power supply cord plug from the AC receptacle. The mains plug of the power supply cord shall remain readily operable.

Français: Pour démonter complètement l'équipement de l'alimentation générale, démonter le câble d'alimentation de son réceptacle. La prise d'alimentation restera aisément fonctionnelle.

 To reduce risk of fire or electric shock, do not expose this apparatus to rain or moisture.

Français: Pour réduire les risques d'incendie ou de choc électrique, n'exposez pas l'appareil à la pluie ou à l'humidité.

 Do not expose this system/apparatus to dripping or splashing and ensure that no objects filled with liquids, such as vases, are placed on the apparatus.

Français: N'exposez pas ce système/appareil au ruissellement ni aux éclaboussures et assurez-vous qu'aucun objet contenant du liquide tel qu'un vase n'est placé sur l'appareil.

 This apparatus must be connected to a mains socket outlet with a protective earthing connection.

Français: Cet appareil doit être raccordé à une prise secteur avec terre de protection.

 The mains plug is used as a disconnect device and shall remain readily operable.

Français: Lorsque la prise du réseau d'alimentation est utilisée comme dispositif de déconnexion, ce dispositif doit demeurer aisément accessible.

3.3. Caution

 To reduce the risk of fire or electric shock, do not remove screws.

No user-serviceable parts inside. Refer servicing to qualified service personnel.

Français: Pour réduire le risque d'incendie ou de choc électrique, ne pas retirer les vis. Aucune pièce réparable par l'utilisateur. Confier l'entretien à personnel qualifié.

3.4. User responsibility

3.4.1. Mains connection grounding

Your amplifier must be connected to a grounded socket outlet.

3.4.2. Speaker output hazard on amplifiers

Amplifiers are capable of producing hazardous output voltages. To avoid electrical shock, do not touch any exposed speaker wiring while the amplifier is operating. The external wiring connected to the speaker terminals shall be installed by a qualified person, or ready-made leads or cords of appropriate capacity shall be used.

As the power output channels on amplifiers produce high voltage, do not connect or disconnect speaker cables when the mains power is on.

3.4.3. Radio interference

A sample of this product has been tested and complies with the limits for the European Electro Magnetic Compatibility (EMC) directive. This equipment has also been tested and found to comply with the limits for a Class A digital device, pursuant to Part 15 of the FCC Rules. These limits are designed to provide reasonable protection against harmful interference from electrical equipment. This product uses radio frequency energy and if not used or installed in accordance with these operating instructions, may cause interference to other equipment, such as radio receivers.

This Class A digital apparatus complies with Canadian ICES-003.
Cet appareil numérique de la classe A est conforme à la norme NMB-003 du Canada.

However, there is no guarantee that interference will not occur in a particular installation. If this equipment does cause harmful interference to radio or television reception, which can be determined by turning the equipment on and off, the user is encouraged to try to correct the interference by one or more of the following measures:

- Reorient or relocate the antenna.
- Increase the separation between the equipment and receiver.
- Connect the equipment to an outlet on a circuit different from that to which the receiver is connected.
- Check if the affected unit complies with the EMC limits for immunity, (CE-labeled). If not, address the problem with the manufacturer or supplier. All electrical products sold in the EC must be approved for immunity against electromagnetic fields, high voltage flashes, and radio interference.
- Consult the dealer or an experienced radio/TV technician for help.

3.4.4. Speaker damage

Amplifier apparatus is very powerful and can be potentially dangerous to both loudspeakers and humans alike. Many loudspeakers can be easily damaged or destroyed by overpowering them. Always check the speaker's continuous and peak power capabilities. Although the amplifiers attenuators can be used to reduce the overall gain, an increase of the input signal can result in full output power, which may cause damage to connected speakers.

3.4.5. Maintenance

For safe and reliable operation, the dust filters on both sides of the front panel, behind the grilles, should be removed and cleaned regularly to ensure maximum airflow through the device.

If the dust filters are not maintained there will be safety risks; for example, high internal temperatures could ignite the dust and start a fire. There is also a risk that the unit will malfunction since it is dependent on constant airflow from front to rear. If the dust filters are not clean and the unit malfunctions, any resulting problems will not be covered by the warranty.

4. Table of Contents

1. Important safety instructions	2
2. Approvals	2
3. Warnings	2
3.1. Explanation of warning symbols	2
3.2. Warnings	2
3.3. Caution	3
3.4. User responsibility	3
3.4.1. Mains connection grounding	3
3.4.2. Speaker output hazard on amplifiers	3
3.4.3. Radio interference	3
3.4.4. Speaker damage	3
3.4.5. Maintenance	3
5. Introduction	6
5.1. Welcome	6
6. Feature summary	6
6.1. Amplifier Platform Features	6
6.2. Lake Processing Features	7
7. Installation	7
7.1. Unpacking	7
7.1.1. Included in the box	7
7.2. Mounting	8
7.2.1. Rear Mounting	8
8. Cooling and fan operation	9

9. Operating voltage	9
9.1. Low voltage country considerations	10
10. Grounding	11
11. Product overview	11
11.1. Front panel	11
11.2. Rear panel	13
12. Signal flow and processing	15
13. Quick Start Tutorial	16
13.1. Network setup	16
13.1.1. Network connections / topology	16
13.1.2. Network configuration	16
13.2. Software installation and firmware update	17
13.2.1. Lake Controller software suite	17
13.2.2. CAFÉ software	17
13.2.3. Firmware update	17
13.3. System setup	18
13.4. Rational Power Management™	21
14. Faults and warnings	23
15. Technical Specifications	26
16. Warranty and support	28
16.1. General	28
16.2. Technical assistance and service	28
16.2.1. International service	28
16.2.2. Factory service	29

5. Introduction

5.1. Welcome

Thank you for choosing the Lab.gruppen PLM+ Series for your sound reinforcement needs. We are confident that you will be pleased with the performance, unique features, configuration flexibility, reliability, and long-term durability offered by this product.

For fast installation and use of this product, your welcome package includes this printed copy of the PLM+ Series Quick Start Guide. It provides a brief introduction to the features and functionality of the PLM+ Series, and it also contains the information required to safely install the product and place it in service. Please read through thoroughly to become acquainted with the basic configuration and control options available. It is recommended that you also review all other product documentation to ensure familiarity with the various configuration and control options.

Thank you again for placing your confidence in Lab.gruppen products.

6. Feature summary

6.1. Amplifier Platform Features

- Four channels with two levels of total available frame power output: 20000 W and 12000 W (@ 2.67 ohms)
- Rational Power Management (RPM)
- True flexibility in allocating power output across each channel to match requirement for more efficient use of amplifier inventory
- Any channel is capable of delivering up to 5900 W power output drawing from total available power in each frame
- Dedicated on-board surveillance and load monitoring for voice alarm applications
- Advanced universal power supply
- Regulated Switch-Mode Power Supply (R.SMPS™) maintains stability through fluctuations in mains voltage
- Best-in-class Power Factor Correction (PFC)
- Current Draw Modeling (CDM™) reduces peak mains draw
- Breaker Emulation Limiter (BEL™) responds to available mains distribution
- Under-Voltage Limiting (UVL™) allows continued operation through mains voltage drop
- CAFÉ (Configuring Amplifiers For the Environment) software incorporates ESP™ (Equipment Specification Predictor) to assist in design, equipment specification and commissioning
- Features controlled by on-board DSP
 - Input Gain (Sensitivity) - Input gain (sensitivity) is set in the digital domain and controlled via CAFÉ software
 - ISVPL™ - The Inter-Sample Voltage Peak Limiter (ISVPL) tailors each channel's power output to the characteristics of the connected load.
 - Load Verification & Performance Monitoring - A comprehensive set of proprietary DSP-based tools enables load verification and real-time performance monitoring.

6.2. Lake Processing Features

- Lake's exclusive classic/linear-phase/FIR speaker processing platform with four throughputs
- Group control with Raised Cosine™ MESA EQ™ asymmetric filters
- LimiterMax™ peak and RMS limiters
- Extensive loudspeaker preset database (Lake LoadLibrary™)
- Comprehensive clocking management system with low latency sample rate conversion
- Full support for Dante Controller
- Multiple and redundant inputs with programmable failover
 - Four "Lake Class" analog inputs with Iso-Float™ ground isolation
 - Two AES3 digital inputs (4 audio channels)
 - Eight dual-redundant Dante network audio inputs
- Comprehensive 3rd party protocol for integration potential with third- party matrix systems via purpose-developed middleware

7. Installation

7.1. Unpacking

Carefully open the shipping carton and check for any damage to the device or the supplied accessories. Every Lab.gruppen product is tested and inspected before leaving the factory and should arrive in perfect condition. If any damage is discovered, please notify the shipping company immediately. Only the consignee may initiate a claim with the carrier or their insurers for damage incurred during shipping. Save the carton and packing materials for the carrier's inspection.

7.1.1. Included in the box

In addition to the PLM+ device, the shipping carton includes the following items:

- PLM+ Quick Start Guide (this document)
- AC mains lead (power cable) with Neutrik® powerCON® connector and AC socket plug according to ordering selection
- Rear brackets for additional rack support (pair) along with associated mounting hardware.

Please keep the original carton and associated packaging to facilitate shipping of the device should the need arise.

7.2. Mounting

PLM+ is made for mounting in 19 inch racks. Four screw holes are available for attachment of the amplifier to the racks front rack rail. This device has no top or bottom vents; therefore, units may be stacked directly on top of one another. Sufficient space should be available at the rear to accommodate connectors and cables. In addition, allowance must be made for cable or loom bends within a rack.

7.2.1. Rear Mounting

Two rear support brackets, along with associated mounting hardware, are included with the PLM+ device. It is strongly recommended that these are used wherever possible. Fit the brackets to the vertical rails at the rear of the rack. The support brackets are reversible and may be fitted to point either to the front or rear of the rack; the proper orientation depends on the rack depth and position of the rear rack rails.

Rear support bracket with mounting hardware

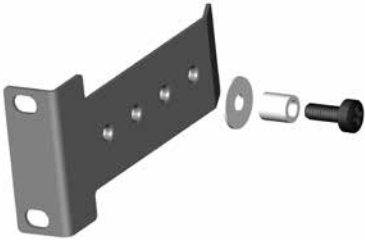

Rear support bracket mounted for fixed installation and bracket pointing forward

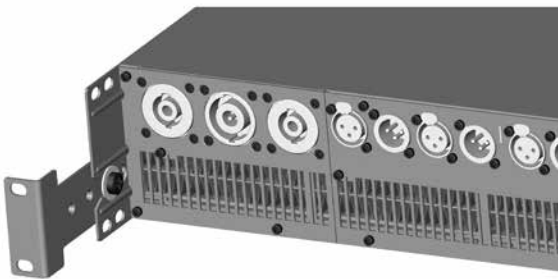

Rear support bracket mounted for removable installation and bracket pointing towards back



8. Cooling and fan operation

PLM+ devices use a forced-air cooling system with airflow from front to rear, allowing high continuous power levels without thermal problems. To facilitate maximum air flow, ensure that no objects such as rack doors or lids are placed at the front or rear of the rack. Never attempt to reverse the airflow. Make sure an adequate air supply is provided in front of the PLM+ device, and that the rear of the device has sufficient space to allow air to escape. It is recommended to keep the ambient temperature around the device as cool as possible. An increased temperature can have a significant negative impact on the expected lifetime on the components inside the PLM+ Series device.



Note: Fit solid blanks (not ventilation blanks) to unused rack spaces to ensure effective air circulation. Leaving gaps in between items of equipment degrades the effectiveness of forced-air cooling.

If installing one or more PLM+ devices in a rack with other fan-cooled equipment, confirm that all other equipment also uses front-to-rear airflow for cooling. If this precaution is not observed, there is a risk of overheating, as units with the reverse airflow will be drawing in air which has already been heated by the PLM+ Series devices.

The PLM+ device is equipped with a sophisticated temperature sensing system which protects it from any overheating which may occur as a result of inadequate ventilation.

9. Operating voltage

PLM+ Series has a universal power supply and its mains nominal and operating voltages are specified in the Technical Specifications (see section 15). PLM+ Series can be ordered with a variety of mains plugs. If the mains plug (AC plug) fitted to the mains cable (AC cord) is not appropriate for your country it can be removed and a locally-sourced one fitted instead. If you are not 100% confident of your competence to replace the mains plug (AC plug), the task should be carried out by qualified personnel.



Note: In-rush current is controlled and limited during the soft-start sequence. This enables multiple PLM+ Series Devices on the same AC mains circuit to be turned on simultaneously.

9.1. Low voltage country considerations

Although the PLM+ Series has a wide range of operating mains voltage, some considerations can be applicable for low voltage regions. PLM+ performs well throughout the specified nominal voltage range but has slightly better efficiency at higher voltages. For regions with nominal voltage below 140 V, one could consider connecting the amplifier in a three-phase delta or two phase split-phase configuration.



Note: Following connections applicable only for resulting voltage inside the amplifiers nominal voltage range.

Connecting the amplifier in three phase delta configuration

In three-phase configuration where the phases are 120 degrees apart, one can connect three balanced loads in a delta configuration. The connection is made between the phases instead of between the neutral and a phase.

Three phase delta configuration

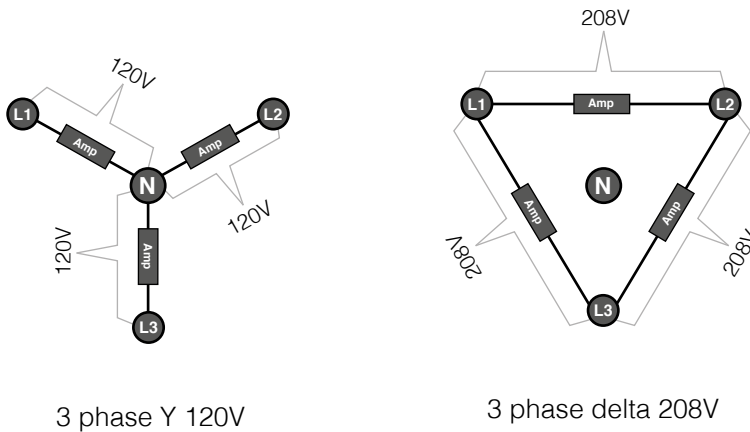

Connecting the amplifier in a split phase configuration

In two phase split-phase configuration there are two phases separated by 180 degrees. Connecting between the phases gives double the line voltage.

Two phase split-phase configuration



10. Grounding

Use correctly-shielded balanced audio input connections to minimize hum and interference.

PLM+ Series must be grounded (earthed) with the safety ground pin to the mains distribution system. NEVER disconnect the earth (ground) pin on the mains cable (AC power cord).

11. Product overview

11.1. Front panel

Additional information on operations using front panel controls is available in the full PLM+ Series Operation Manual.

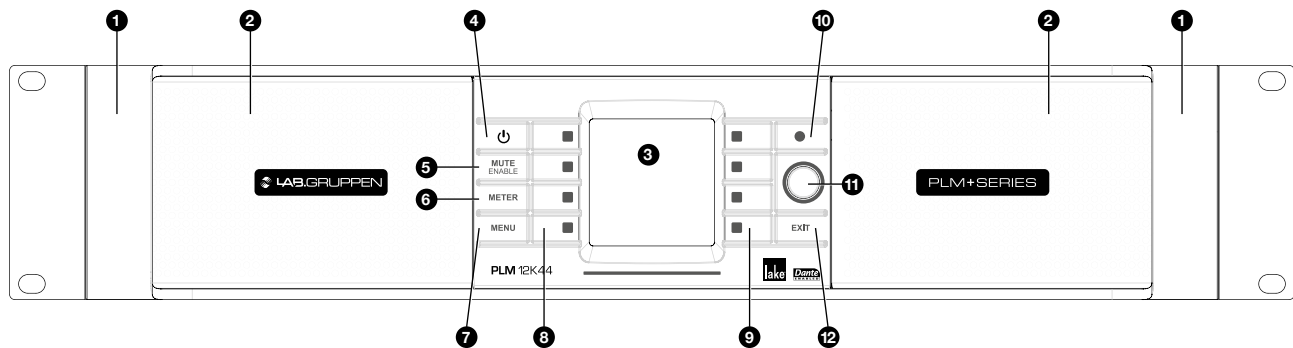

1 Handles – Handles should be used when carrying, and when fitting into or removing from a rack. Ensure that rack doors or covers have sufficient depth to clear the handles.

2 Dust Filters – Two dust filters are located behind metal covers. Loosen thumbscrews behind the handles to remove covers and remove filter elements for cleaning.



Note: NEVER operate this device without the dust filters in place.

3 Display – The display illuminates when device is on. Brightness and contrast can be adjusted via the front panel menu. A Screen Saver function turns off the display after four minutes of no activity. Press any button to turn on the display.

4 Standby – Switches device between On and Standby power modes.

- ⑤ **Mute Enable** – Selection of MUTE ENABLE allows dynamic function buttons to operate as Mute controls for the module inputs and power output channels. The MUTE ENABLE button flashes when the mode is selected; a subsequent press deselects the mode. If left activated, MUTE ENABLE mode will automatically disable two minutes after last mute action.
- ⑥ **Meter** – Successive presses of the METER button scroll through meter views: Amp, Temperature, Input and Module meters, returning to Home. Pressing METER from Menu Mode returns display to Meter Mode Home view.
- ⑦ **Menu** – Pressing the MENU button changes the display to the top level menu, with dynamic function buttons enabling access to various information displays and function settings.
- ⑧ **Dynamic Function Buttons with LEDs (Left of LCD)** – The function of these buttons change according to the currently selected view or menu.
- In Menu Mode they are used for menu navigation and for parameter selection
 - In Meter mode they provide Mute/Unmute function for the four inputs in conjunction with MUTE ENABLE. Internal mute point(s) depend on selected meter view. The four LEDs display mute status (red= mute, green = unmute) as well as fault and warning indications. Global faults and warnings are indicated by simultaneous illumination of all four LEDs. Please refer to full Operation Manual for more information.
- ⑨ **Dynamic Function Buttons with LEDs (Right of LCD)** – The function of these buttons change according to the currently selected view or menu.
- In Menu Mode they are used for menu navigation and for parameter selection
 - In Meter mode they provide Mute/Unmute function in conjunction with MUTE ENABLE. Internal mute point(s) depend on selected meter view. Please refer to full Operation Manual for more information.
- All LEDs provide mute, clip, fault and warning indication for the power output channels.
- ⑩ **Communication LED** – Steady white illumination indicates Module/Frame is selected in Lake Controller; flashing indicates communication with Lake Controller. Brightness is adjustable in the Frame page of Main menu.
- ⑪ **Rotary Encoder** – Turning the encoder modifies various parameters in the menu. The ring around the encoder illuminates whenever a menu item is selected that permits adjustment of values. In Home view, the encoder is used to scroll through Meter views.
- ⑫ **Exit** – Pressing EXIT returns the menu up one level when navigating in Menu mode. In Meter mode, EXIT returns display to Home view.

11.2. Rear panel

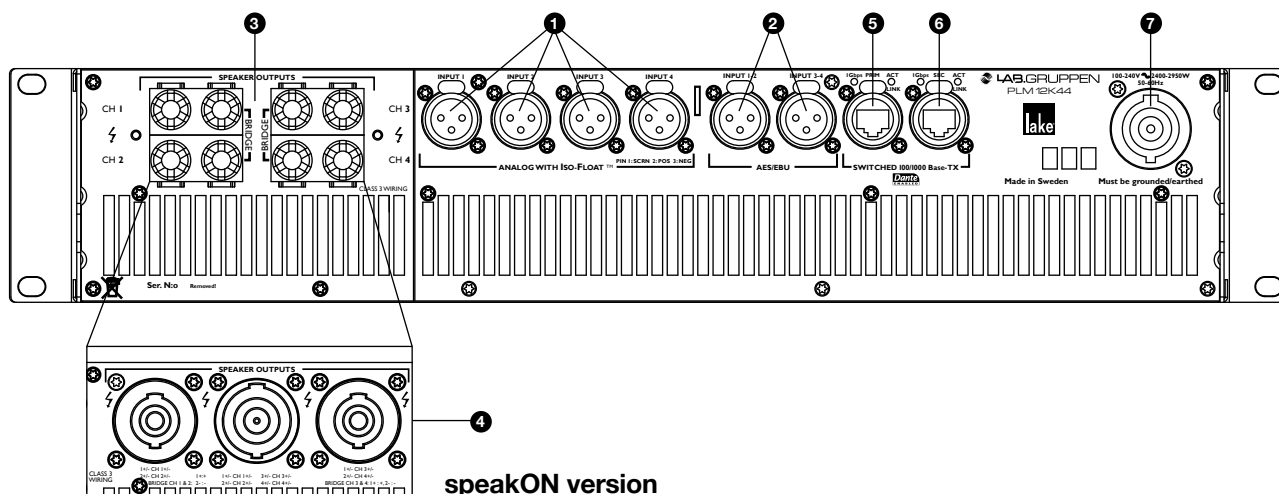

Input Connectors

- ❶ **Analog Inputs** – Four analog inputs are available on standard XLR-3F connectors, electronically balanced and featuring Lake Iso-Float circuitry. Impedance is 20 kohms; maximum input level is +26 dBu.
- ❷ **AES3 Inputs** – Two latching XLR-3F connectors accept four channels of AES3 digital audio. Input impedance is 110 ohms; ensure that 110 ohm digital audio cables are used.

Output Connectors

Your device will be equipped with one of the two output connector options. Both options allow for Bridge Mode operation, which is activated in the Lake Controller software. Please refer to the Lake Controller Operation Manual for more information.

- ❸ **Binding Posts** – Power outputs are available on four separate pairs of fully enclosed binding posts.
- ❹ **speakON connectors** – Power outputs are available simultaneously on a single 8-pole connector and on two 4-pole connectors. The four-pole connectors carry outputs for channels 1&2 and 3&4 respectively.

Ethernet and Power Connectors

- ❺ **Primary Network Connector** – The primary Neutrik RJ45 etherCON® connection provides integration into an Ethernet control network which may include other Lake Processors and the Lake Controller software. Network connection permits full control of all functions along with real-time metering from a remote position. This device supports the Dante audio networking protocol for multichannel, high-definition digital audio over the same Ethernet connection.

11. Product overview

Use the primary connector when using a star network topology, consisting of individual Cat-5e connections between the devices and an Ethernet switch. Alternatively, this connection can be used to daisy chain directly to another Lake Processor. The daisy chain topology should not be used with Dante.

For a technical reference of the Ethernet Port, please refer to the full PLM+ Series Operation Manual. Additional information is also available in the Lake Network Configuration Guide.



Note: Additional processor configuration is required for a dual redundant network setup. See the Lake Controller Operation Manual for further details.



Note: Do not create a closed loop when configuring multiple devices in an Ethernet network; this will cause a network malfunction.

6 Secondary Network Connector – The secondary network connector can be used to daisy-chain multiple PLM+ Series devices. Alternatively, a Dante dual-network topology can be created by connecting all secondary network connectors to a separate Ethernet switch, ensuring full redundancy in the event of a network component failure.

7 Mains Power Connector – AC mains input is via a Neutrik powerCON connector, rated at 32A. Connector mates with supplied AC mains cable. See previous section on Operating Voltage for more information.

12. Signal flow and processing

The table below depicts the audio signal flow for a PLM+ device.

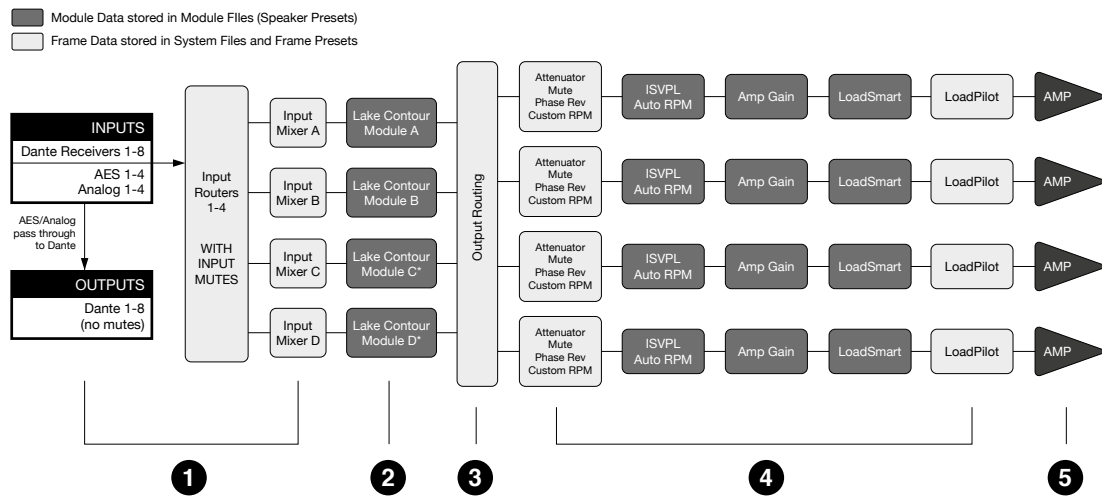

- ❶ The input section (inputs, input router and input mixer) allows for mixing capabilities as well as redundant and prioritized inputs with automatic switch-over in case of signal failure.
- ❷ Up to four Lake Processing modules provide user EQ and loudspeaker processing, including LimiterMax limiting.
- ❸ The Output router allows free routing between module outputs and power output channels.
- ❹ Each power output channel provides individual channel processing, including ISVPL limiter, RPM and load monitoring.
- ❺ Power Amplifier

13. Quick Start Tutorial

This section will describe how to get started with associated software and set up a basic system for operation.

13.1. Network setup

13.1.1. Network connections / topology

Each frame has two network ports; a primary and a secondary. See the below diagram for a typical network topology using the primary ports.

By default, the secondary ports are configured in dual redundancy mode to support a second redundant network. The alternate configuration for the two ports is a switch mode which allows daisy-chaining devices in a single network. Daisy chain mode is not recommended for more than a few devices, and for not more than two if running Dante audio along with control data.

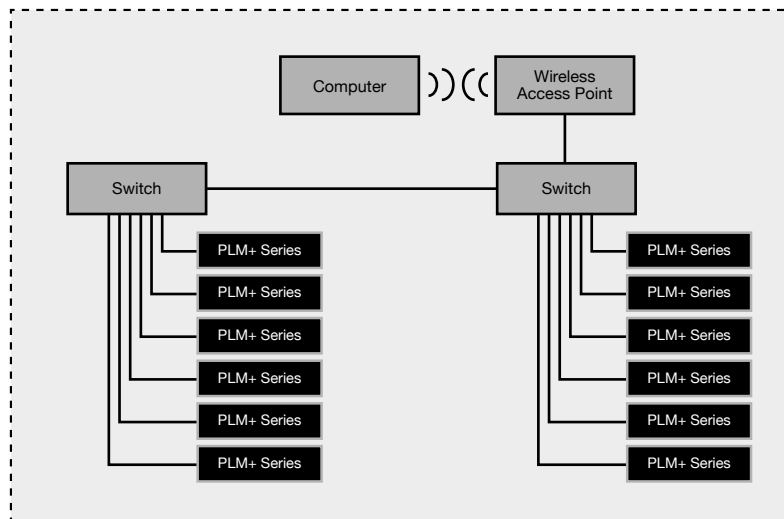

Note: If using Dante audio in the network, the audio traffic needs to be filtered from reaching the wireless links.

13.1.2. Network configuration

Frames are configured by default to obtain IP addresses automatically. The frame will assign itself an IP address in the link local range (169.254.1.0 through 169.254.254.255). If a computer is configured the same way (which should be default on modern operating systems), it will reside in the same subnet as the devices and communication can be established. Alternate configurations would be DHCP for a managed network or fixed IP. To connect to the secondary network in dual redundancy mode the computer shall be configured with an IP address in the 172.31.0.0 - 172.31.255.255 range.

13.2. Software installation and firmware update

13.2.1. Lake Controller software suite

1. The Lake controller software suite includes the Lake controller and accompanying utilities: Lake LoadLibrary and Dante discovery services. Download the Lake Controller installation from www.labgruppen.com.
2. Execute the installer and follow the on-screen instructions. This is a typical software installation where the default settings are acceptable for the vast majority of users.

13.2.2. CAFÉ software

1. The CAFÉ software is available as a separate installer on www.labgruppen.com.
2. Execute the installer and follow the on-screen instructions. This is a typical software installation where the default settings are acceptable for the vast majority of users.

13.2.3. Firmware update

The latest firmware for the product is included in the Lake controller installation. It is likely that firmware installed on the new product is older and requires updating.

1. Make sure all frames are powered on and connected through a wired network.
2. Launch the Lake firmware update utility LakeUpdate.exe.
3. Select the appropriate product range.
4. If more than one network adapter is enabled, a prompt will appear requiring selection of the adapter connected to the frames.
5. If prompted, allow the application access through the Firewall.
6. Latest firmware is preselected.
7. Discovered frames are listed. Tap Select Old and Update to initiate firmware update of all outdated frames. Frames already up to date will not be selected.
8. Read warning message and tap OK.
9. Wait for all updates to be completed. A wait indication will display on the unit(s) during updating. (Four corner LEDs will blink yellow in circular pattern.)
10. Tap OK and cycle the mains power on all updated frames by completely removing the power plug and reinserting it. (Note: The standby button does not complete the firmware update).
11. If internal updates are needed, these will be performed by the frame after the power cycle. A wait indication is displayed. This process can take ten minutes or more. When concluded, if the top left LED blinks yellow, another power cycle is required.
12. Tap Exit to close the update utility.

13.3. System setup

This tutorial provides a step-by-step guide for configuration of a typical professional loudspeaker system and provides an overview of the basic features and operation of the frame. It describes how to configure 4-channel frame for use with a generic 3-way loudspeaker system (with separate HF, MF and LF drivers), plus a separate subwoofer. It assumes that the system is fed with analog outputs from a mixing console with one fullrange main output and a separate sub feed.

1. Connect the loudspeakers to the four power output channels:
 - a. Channel 1 – Low Frequency Driver
 - b. Channel 2 – Mid Range Driver
 - c. Channel 3 – High Frequency Driver
 - d. Channel 4 – Subwoofer
2. Connect the main output of the mixing console to analog input 1 of the frame and the sub feed to input 2. While configuring, it is a good practice to make sure the volume is turned down on the console.
3. Ensure the frame is powered on and is in its default state, and that the computer has established an active Ethernet connection.
4. On the Tablet PC, launch the Lake Controller software application. Select the appropriate network adapter if more than one is enabled, and tap NO to the dialog asking whether to load the previous configuration.
5. Tap MODULES button on the menu bar at the bottom of the screen to access the Module Menu and scroll bar.
6. On the Module scroll bar, the frame is represented with a frame containing four discs. These are labeled A, B, C and D, each representing one of the four Lake processing modules.
7. Tap the frame to select it, then tap again in the MAIN area of the screen to place all modules of the frame in the current system configuration. The Lake Controller uploads settings from the frame.



8. Tap the icon for Module A; its border will turn yellow to confirm selection and an LED on the front panel of the associated device will illuminate.
9. Tap the Module Store/Recall button on the Modules Menu; the menu will change to show additional options.
10. Double-tap the Default Modules folder, then double-tap the Contour Classic Crossovers folder. A set of loudspeaker symbols will be displayed.
11. Tap CL3way, and then tap the RECALL button. This configures the DSP for the Module A as a 3-way crossover for the 3 way speaker.
12. Tap Yes when asked to confirm that all data will be overwritten.
13. An Output configuration dialog will pop up to allow for routing of module outputs to power channels. Tap the orange number buttons in the matrix to un-route, freeing up a power channel. Tap a blue number button at the intersection of the appropriate module output and power channel, routing the module output to the power channel. Proceed until you have routing according to the picture across. Tap the bottom right return button to exit the dialog.

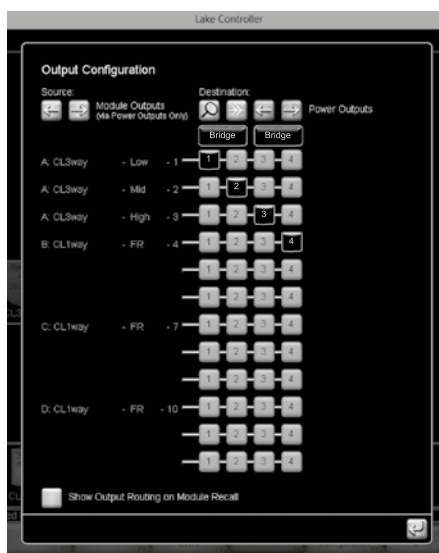

14. The B module is already a CL1way as default and can be used to drive the sub.
15. Tap Store/Recall EXIT to return to the Modules Menu.
16. Ensuring Module A (or any other module that you want to control) is selected (yellow border), tap I/O Config.



17. The right side of the I/O CONFIG screen displays a block diagram for the Modules. Tapping the different blue blocks will access the configuration screens for Input mixer, Levels, Input EQ, Delay and Output EQ/Crossover respectively. The magnifying glass at the far right end accesses the output configuration. (Note: Tapping the blue return button (left arrow), or the EQ/Levels EXIT button in the menu bar returns to the I/O Config screen from the various configuration screens.)

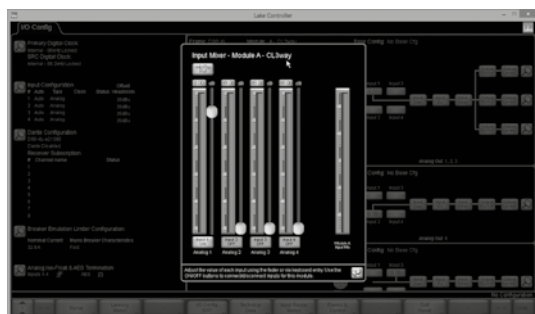

Input Mixer Configuration - Drag sliders and tap ON/OFF buttons to control input mixer settings.

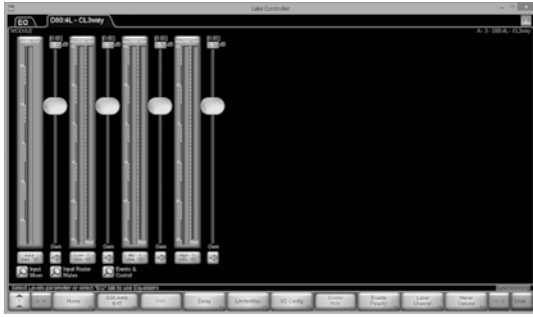

Levels Control - Drag sliders and tap mute buttons for module input and output channels.

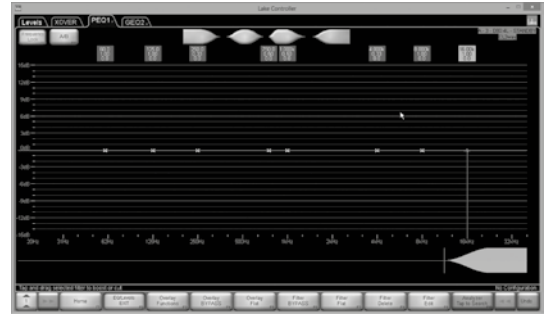

Parametric EQ control – Select filter on the top squares and adjust filter properties by dragging the controls. Sliders at the bottom control center frequency and Q (bandwidth). Gain is controlled in the main window area. Additional filters can be added by tapping the top filter objects and placing new filters on the main area.

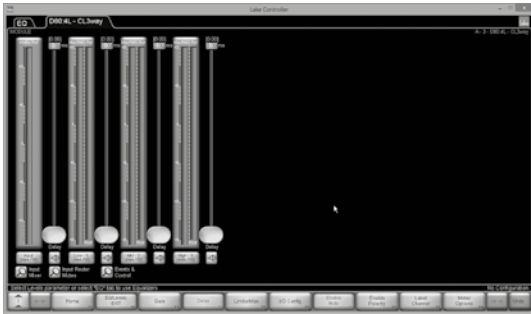

Delay Control - Drag sliders to control input and output delay

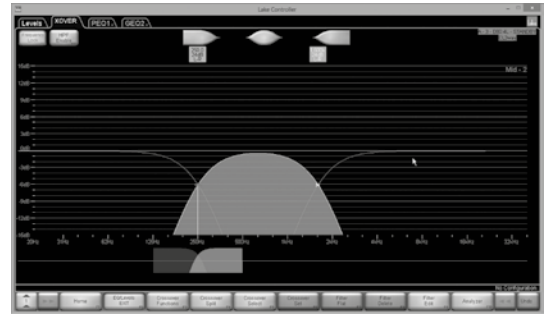

Crossover control – Select filters and drag on the bottom frequency bar to adjust crossover frequency. Crossover types may be changed by selecting the Crossover Functions button.

18. Tap the Input Gain button in the block diagram and unmute the Module Input Mute. Tap EQ/Levels Exit to return to IO Config.
19. The left side of the IO config screen holds frame configuration and summary for Clock configuration, Input configuration, Dante configuration, Breaker Emulation Limiter configuration and Analog Iso-Float & AES Termination configuration. All these configurations should be correct by default for this example.
20. From I/O CONFIG, tap EVENTS & CONTROL and navigate to the STATUS tab. If muted, unmute the power channels and slowly increase the volume on the appropriate feed from the mixing console. Audio should now be active at the outputs and heard through the loudspeakers. Close the Events and Control dialog with the return button and return to the main area by tapping the I/O Config EXIT button.

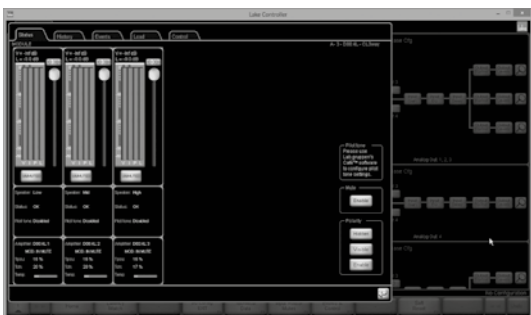

Events & Control, Status tab – Drag sliders to adjust power channel attenuation and tap mute buttons to control power channel mute. Metering and Status monitoring is available for each power channel.

21. Repeat step 16 and 20 for the B module. On the Output EQ/Crossover, tap the Aux Output Functions button on the menu bar and then tap LPF Enable button. Drag the Low pass filter control object on the frequency slider just above the menu bar to an appropriate crossover frequency for the sub, e.g. 100 Hz.

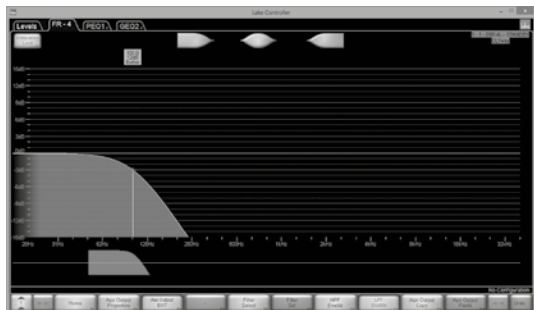

Output EQ control - Add LPF/HPF and EQ filters and drag to adjust.

22. Use the control options mentioned in 17 to tune your loudspeakers. For larger systems, modules can be placed in groups (Groups menu from the MAIN page) for control of multiple units.

13.4. Rational Power Management™

Rational Power Management™ (RPM) is a unique Lab.gruppen feature that allows for flexible allocation of power across channels of a PLM+. Power that is not used by one output channel is free for use by another output channel with greater demands. RPM allocates power up to the total limits of the specific amplifier model. RPM exists in two modes. See the image below.

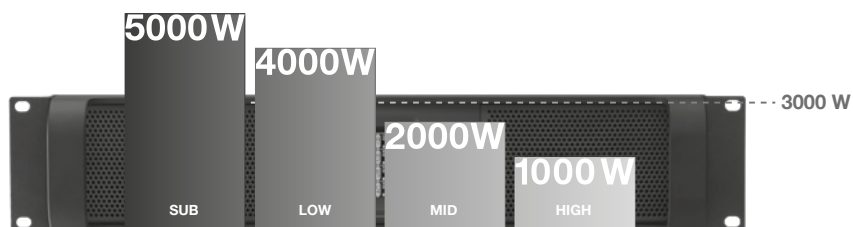

PLM 12K44 - Amp channels power adjusted to match the loudspeaker requirements

Auto RPM:

The frame will automatically allocate power per output channel according to the ISVPL settings in the Lake module. If the ISVPL settings taken together allow total output higher than the capabilities of the amplifier, RPM will reduce the ISVPL limiter thresholds evenly based on a proportional reduction in dB. When RPM is active, an RPM icon will be displayed next to the “Actual ISVPL” values in the Events & Control section.



Custom RPM:

The Café software allows users to create an advanced custom power allocation scheme. Switching to Custom mode disables the Automatic mode. When RPM is active an RPM icon will be displayed next to the “Actual ISVPL” values in the Events & Control section. Please find more information about this in the CAFÉ Operation Manual



CAFÉ with ESP: Integrated software for efficient project planning and fast system configuration

CAFÉ (Configuring Amplifiers For the Environment) is a dedicated software application for Windows and OSX that provides tools for system planning, specification and commissioning. CAFÉ improves work flow efficiency at every stage of the project, from initial design through bid tender and final system optimization.

14. Faults and warnings

Category/Type	Name	On screen text	Description	Action
FRAME				
Warning	Lake Controller offline	CTRL OFFLINE	Frame unable to find Lake controller on the network	Check network cabling/ network if controller expected on the network
Warning	AES clock slipping	CLOCK SLIPPING	Frame not able to lock to incoming AES stream	Check AES sender and clock configuration
Warning	Dante device name conflict	NAME CONFLICT	Two or more devices on the network with the same Dante name	Review Dante configuration
Warning	Dante module not detected	DANTE NEEDS SERVICE	Lake cannot detect a functioning Dante module	Restart device; if not cleared it needs service to operate Dante
Warning	Dante module with incompatible firmware	DANTE FW INVALID	Dante module not loaded with correct FW	Retry updating the firmware with LakeUpdate
Fault	Audio Fault	AUDIO FAULT	Internal audio interface not functioning	Restart device; if not cleared it needs service
Fault	Sense fault DSP	SENS FLT:DSP	Voltage and current sensing on amplifier output faulty. Audio continues but protection might be compromised. No load monitoring	Restart device; if not cleared it needs service
Fault	A/D converter power supply fault	A/D PSU FAULT	Voltage supply to the analog input converters faulty	Restart device; if not cleared it needs service for analog input to work
TEMP				
Warning	Temperature warning power supply	TEMP WARN:PSU	Power supply temperature approaching critical levels	Improve cooling or reduce output power to avoid temperature becoming critical
Warning	Temperature warning DSP area	TEMP WARN:DSP	DSP area temperature approaching critical levels	Improve cooling or reduce output power to avoid temperature becoming critical
Warning	Power supply Temperature Limit	PTL ACTIVE	Amplifier is reducing output power to avoid power supply temp fault protection	Improve cooling or reduce output power to avoid limiting
Warning	Amp channel Temperature Limit	ATL ACTIVE	Amplifier channel is reducing output power to avoid amplifier channel temp fault protection	Improve cooling or reduce output power to avoid limiting
Fault	Temperature fault power supply	TEMP FLT:PSU	Power supply temperature reached internal protection limit	Automatically restarts when cooled down
Fault	Temperature fault DSP area	TEMP FLT:DSP	DSP area reached critical temperature	Improve cooling or reduce power

14. Faults and warnings

Category/Type	Name	On screen text	Description	Action
PSU				
Warning	Under Voltage Limit	UVL ACTIVE	The Under Voltage limiter is active as the mains supply is approaching the lower end of the device's operational voltage. Output power is decreased to ensure mains distribution does not collapse	Increase mains distribution stiffness or reduce output power to avoid limiting
Warning	Power Average Limit	PAL ACTIVE	Amplifier is reducing output power due to average power or mains current draw is above safe operating levels	Reduce output power to avoid limiting
Warning	Breaker Emulation Limit	BEL ACTIVE	Power supply is reducing mains current draw to stay within BEL configured nominal current and profile	Improve mains distribution and update BEL configuration or reduce output power to avoid limiting
Warning	Mains supply glitch	MAINS GLITCH	Mains glitch (missing cycles) was detected on the mains inlet	Check mains distribution/connection
Warning	Upgrade power supply firmware	UPGRADE PSU	Power supply firmware version not compatible with amplifier	Upgrade amplifier firmware
Fault	Need service	NEED SERVICE:1-8	Power supply internal error	Restart device; if not cleared it needs service
Fault	Mains voltage above 400 volt peak	MAINS>400 VPK	Power supply detects mains voltage above 400 volt peak. Protective shut down, auto restart attempt	Check mains distribution/connection
Fault	Mains voltage above 270 V	MAINS>270 V	Power supply detects mains voltage above operation voltage. Protective shut down, auto restart attempt	Check mains distribution/connection
Fault	Mains voltage below 65 V	Mains<65 V	Power supply detects mains voltage below operation voltage. Protective shut down, auto restart attempt	Check mains distribution/connection
Fault	Power supply fault	PSU FAULT	Internal power supply fault	Check mains distribution/connection. Restart device; if not cleared it needs service
Fault	Check mains	CHECK MAINS	Power supply detects unstable mains supply. Protective shut down, auto restart attempt	Check mains distribution/connection
Fault	Power supply power protect	PSU POWER PROT	Too high output power for too low mains supply voltage. Protective shut down, auto restart attempt	Improve mains supply voltage or reduce output power
LOAD				
Warning	Speaker short	SPKR SHORT	Both LoadPilot tones below thresholds	Check load or calibration
Warning	Speaker damaged	SPKR DAMAGED	One LoadPilot tone is above or below threshold	Check load or calibration
Warning	Under speaker count	UNDER SPKR CNT	Both LoadPilot tones above thresholds or LoadSmart detected fewer speakers than expected	Check load and cabling alibration

Category/Type	Name	On screen text	Description	Action
Warning	More speakers	OVR SPKR COUNT	LoadSmart detected more speakers than expected	Check load and cabling or fingerprint
Warning	Uncertain about load	UNCERTAIN LOAD	LoadSmart uncertain about load	Check load and cabling or fingerprint
Warning	Load not verified	LOAD NOT VER	LoadSmart not verified	Perform LoadSmart verification
Fault	No load	NO LOAD	At least one LoadPilot tone above measurable area or significantly above thresholds	Check load or calibration
Fault	Wrong load	WRONG LOAD	LoadSmart detected impedance response output model	Check load and cabling or fingerprint
Fault	Short circuit	SHORT CIRCUIT	LoadPilot or full frequency analysis below short threshold or hardware short protection	Check load and cabling
AMP				
Warning	Temp warning amplifier channel	TEMP WARN	Amplifier channel is approaching critical temperature	Improve cooling or reduce output power to avoid temperature becoming critical
Fault	Temp Fault amplifier channel	TEMP FAULT	Amplifier channel has reached internal protection limit	Automatically unmutes when cooled down
Fault	Service channel	SERVICE CH.	Amplifier channel is damaged	Restart device; if not cleared it needs service
Fault	Very high frequency fault	VHF FAULT	Amplifier channel protection	Check input signal
Clip	Current average limiter	CAL ACTIVE	Average current on amplifier above safe operating level	Reduce output power to avoid limiting
Clip	Current clip	CURRENT CLIP	Amplifier channel reached current limit	Reduce output power to avoid limiting
Clip	Voltage clip	VOLTAGE CLIP	Amplifier reached voltage limit	Reduce output power to avoid limiting
Clip	Module clip	MOD. CLIP	Module output signal clipped	Review gain structure. Module gain vs AmpGain
SIGNAL				
Fault	No input source	NO INPUT	Input router has no valid input source	Review input router settings/connections
Clip	Analog/AES input clip	INPUT CLIP	The signal on the analog/AES input is above inputs capability	Lower the signal on the feed to the amplifier

15. Technical Specifications

	PLM 12K44	PLM 20K44
General		
Processing / Network	Lake / Dante	Lake / Dante
Numbers of amplifier channels	4	4
Total burst power all channels (share among channels with RPM)	12000 W	20000 W
Max. Output Power (all ch.'s driven) ¹⁾		
2 ohms	3000 W	4400 W
2.67 ohms	3000 W	5000 W
4 ohms	3000 W	4400 W
8 ohms	1900 W	2300 W
16 ohms	950 W	1150 W
Hi-Z 70 V	3000 W	3300 W
Hi-Z 100 V	3000 W	4700 W
Max output power single channel ¹⁾		
2 ohms	4400 W	4400 W
2.67 ohms	5900 W	5900 W
4 ohms	4600 W	4600 W
8 ohms	2300 W	2300 W
16 ohms	1150 W	1150 W
Hi-Z 70 V	3300 W	3300 W
Hi-Z 100 V	4700 W	4700 W
Amplifier output modules (all models, all channels)		
Peak output voltage	194 V	194 V
Max output current	67 A	67 A
Rational Power Management (RPM)	Any channel has potential to deliver the max single channel output power	Any channel has potential to deliver the max single channel output power
Default voltage limitation (can be lifted with RPM configuration)	175 V	194 V
Protection features	Current Average Limiter (CAL), Very High Frequency Protection (VHF), Direct Current Protection (DC), Short Circuit Protection, Current-Clip Limiter, Voltage Clip Limiter, Temperature protection	Current Average Limiter (CAL), Very High Frequency Protection (VHF), Direct Current Protection (DC), Short Circuit Protection, Current-Clip Limiter, Voltage Clip Limiter, Temperature protection
Audio Performance (Amplifier platform with digital input)		
THD + N 20 Hz - 20 kHz for 1 W	< 0.05 %	< 0.05 %
THD + N at 1 kHz and 1 dB below clipping	< 0.04 %	< 0.04 %
Dynamic range	> 114 dB	> 114 dB
Channel separation (Crosstalk) at 1 kHz	> 70 dB	> 70 dB
Frequency response (1 W into 8 ohm, 20 Hz - 20 kHz)	+/- 0.05 dB	+/- 0.05 dB
Internal sample rate / Data path	96 kHz / 32 bit floating point	96 kHz / 32 bit floating point
Product propagation delay AES 96 kHz / analog input	1.61 / 1.68 ms	1.61 / 1.68 ms
Lake processing		
Loudspeaker processing	Up to 4 modules of Classic/linear-phase/FIR cross-over, EQ, delay, LimiterMax™ - peak and RMS limiters	Up to 4 modules of Classic/linear-phase/FIR cross-over, EQ, delay, LimiterMax™ - peak and RMS limiters
System tuning	Group control with Raised Cosine™ MESA EG™ asymmetric filters	Group control with Raised Cosine™ MESA EG™ asymmetric filters
Input redundancy / Matrix	Automatic 4 level input redundancy / 4 input mixers	Automatic 4 level input redundancy / 4 input mixers
System integration	Comprehensive 3rd party protocol over UDP Ethernet	Comprehensive 3rd party protocol over UDP Ethernet
Measurement & Analysis		
Pilot tone generation and analysis	Yes	Yes
Load impedance analysis	Yes	Yes
Real Time Analyzer (RTA), 3rd party integration	Yes	Yes
Dante Audio Network		
Dante I/O	8 x 8	8 x 8
Network topology / redundancy	Flexible topology / Supports Dual redundant networks	Flexible topology / Supports Dual redundant networks
Sample rates / transport	48, 96 kHz / Uni + Multicast	48, 96 kHz / Uni + Multicast
Network latency	0.25, 0.5, 1.0, 2.0, 5.0 ms	0.25, 0.5, 1.0, 2.0, 5.0 ms
Device Presets		
Local memory locations for the settings of the product	100	100
AES Inputs		
Inputs	4 AES inputs	4 AES inputs
Supported sample rates/ resolution	44.1, 48, 88.2, 96, 176.4, 192 kHz / up to 24 bits	44.1, 48, 88.2, 96, 176.4, 192 kHz / up to 24 bits
Sample rate conversion THD + N 20 Hz - 20 kHz unweighted	0.00003 %	0.00003 %
Analog Inputs		
Inputs	4 high quality inputs with Iso-Float™ ground isolation	4 high quality inputs with Iso-Float™ ground isolation
Maximum input / digital reference	+ 26 dBu / + 21 dBu	+ 26 dBu / + 21 dBu
Sampling rate / resolution	96 kHz / 24 bit	96 kHz / 24 bit
Input impedance balanced / unbalanced	20 k / 10 k ohm	20 k / 10 k ohm
THD + N (typical at 1 kHz unweighted)	0.00022 %	0.00022 %
THD + N (typical at 20 Hz and 20 kHz unweighted)	0.00033 %	0.00033 %
Limiters		
Adjustable Inter-Sample Voltage Peak Limiter (ISVPL)	17.8 - 194 V, step size 0.1 V	17.8 - 194 V, step size 0.1 V
Current Peak Limiter < 300 ms	67 A peak	67 A peak
Current Average Limiter (CAL) > 300 ms	33 Arm	33 Arm
LimiterMax (rms and peak limiters)	Yes	Yes
MaxRMS (rms voltage limiter)	Yes	Yes
MaxPeak (peak voltage limiter)	Yes	Yes

	PLM 12K44	PLM 20K44
Gain		
Amplifier gain	22 - 44 dB, step size 0.1 dB	22 - 44 dB, step size 0.1 dB
Analog attenuator	- Inf to 0 dB, step size 0.25 dB	- Inf to 0 dB, step size 0.25 dB
Rear-panel interface		
Analog inputs	4 x 3 pin XLR, electronically balanced	4 x 3 pin XLR, electronically balanced
AES inputs	2 x 3 pin XLR	2 x 3 pin XLR
Output connectors	Neutrik speakON (1 x NLT8, 2 x NLT4) or 4 binding posts (pairs)	Neutrik speakON (1 x NLT8, 2 x NLT4) or 4 binding posts (pairs)
Auto 100/1000, Auto Uplink	2 x RJ45 etherCON	2 x RJ45 etherCON
Control and monitoring interface	Via Ethernet for Lake Controller software, or DLM (the 3rd party protocol)	Via Ethernet for Lake Controller software, or DLM (the 3rd party protocol)
Detachable mains cord	Neutrik powerCON 32 A	Neutrik powerCON 32 A
Cooling	Three fans front-to-rear airflow, temperature controlled speed	Three fans front-to-rear airflow, temperature controlled speed
Front-panel interface		
Display	2.5 inch, Black / white, daylight readable LCD	2.5 inch, Black / white, daylight readable LCD
Fault / Warning / Limit / Clip indicators	RGB LED's and detailed fault description on display	RGB LED's and detailed fault description on display
Mute and soft function buttons	8 provided	8 provided
Standby Power button	On / Standby	On / Standby
Mute Enable button	Enables muting of outputs and inputs via soft-button keypad	Enables muting of outputs and inputs via soft-button keypad
Meter button	Toggles through meter views	Toggles through meter views
Menu button	Provides a menu driven interface for full function front panel control	Provides a menu driven interface for full function front panel control
Rotary Encoder	Yes	Yes
Exit button	Provides a "back" function	Provides a "back" function
Mains power		
Nominal voltage	100 - 240 V AC 45- 66 Hz	100 - 240 V AC 45- 66 Hz
Operating voltage	70 - 265 V AC	70 - 265 V AC
Mains wall plug	NEMA L5-30 "Twist lock" 125 V / 30 A, and CEE 7/7 "Schuko" 230 V / 16 A	NEMA L5-30 "Twist lock" 125 V / 30 A, and CEE 7/7 "Schuko" 230 V / 16 A
Power supply features		
Soft start / Inrush power	Yes / Max 8 Ampere	Yes / Max 8 Ampere
Power Factor Correction (PFC)	0.98	0.98
Regulated switch mode power supply	Yes	Yes
Breaker Emulation Limiter (BEL)	Configurable current threshold and breaker profile	Configurable current threshold and breaker profile
BEL max current threshold	25 A	32 A
Power Average Limiter (PAL)	Yes	Yes
Under Voltage Limiter (UVL)	Yes	Yes
Mains under voltage and overvoltage protection and mains glitch tolerance	Yes	Yes
Dimensions		
Rack rail to rear panel	W: 483 mm (19"), H: 88 mm (2 U), D: 424 mm (16.7")	W: 483 mm (19"), H: 88 mm (2 U), D: 424 mm (16.7")
Overall depth including handles and rear support	D: 498 mm (19.6")	D: 498 mm (19.6")
Weight	16.5 kg (36 lbs)	17 kg (37 lbs)
Finish	Black painted steel chassis with black painted steel / aluminium front	Black painted steel chassis with black painted steel / aluminium front
Approvals	CE, ANSI / UL 60065 (ETL), CSA C22.2 NO. 60065, FCC, PSE, RCM, BIS India	CE, ANSI / UL 60065 (ETL), CSA C22.2 NO. 60065, FCC, PSE, RCM, BIS India

Note 1): Lab.gruppen burst power (1 kHz, 25 ms burst power @ 150 BPM, 12 dB Crest factor)

All specifications are subject to change without notice.

Intercooler, Class TD and Lake are national and/or international registered trademarks of Lab.gruppen AB. PLM, Powered Loudspeaker Management, R.SMPS, LoadLibrary, LoadSmart, SpeakerSafe, BEL, UVL and ISVPL are trademarks of Lab.gruppen AB. Dolby and the double-D symbol are registered trademarks of Dolby Laboratories. Contour, Mesa Quad EQ, Mesa Parametric EQ, Raised Cosine Equalization, LimiterMax and Iso-Float are trademarks of Dolby Laboratories. Audinate is a registered trademark of Audinate Pty Ltd. Dante and Zen are trademarks of Audinate Pty Ltd. All other trademarks remain the property of their respective owners.

Copyright © 2014 Lab.gruppen AB.

All rights reserved.

16. Warranty and support

16.1. General

This product is manufactured by Lab.gruppen, and it is warranted to be free from any defects caused by components or factory workmanship, under normal use and service, for a period of six (6) years from date of purchase from an authorized Lab.gruppen dealer. If the product fails to perform as specified during the warranty period, Lab.gruppen will undertake to repair, or at its option, replace this product at no charge to its owner, provided the unit is returned undamaged, shipping prepaid, to an authorized service facility or to the factory. This warranty shall be null and void if the product is subjected to: repair work or alteration by a person other than those authorized by us; mechanical damage including shipping accidents; war, civil insurrection, misuse, abuse, operation with incorrect AC voltage; incorrect connections or accessories; operation with faulty associated equipment; or exposure to inclement weather conditions. Damage due to normal wear and tear is not covered by the warranty. Units on which the serial number has been removed or defaced will not be eligible for warranty service. Lab.gruppen shall not be responsible for any incidental or consequential damages. Lab.gruppen's responsibility is limited to the product itself. Lab.gruppen takes no responsibility for any loss due to cancellation of any events, or rent of replacement equipment or costs due to a third party's or customer's loss of profit, or any other indirect cost or losses however incurred. Lab.gruppen reserves the right to make changes or improvements in design or manufacturing without assuming any obligation to change or improve products previously manufactured. This warranty is exclusive, and no other warranty is expressed or implied. This warranty does not affect the customer's statutory rights.

International Warranties

Please contact your supplier or distributor for this information, as rights and disclaimers may vary from country to country.

16.2. Technical assistance and service

16.2.1. International service

If your Lab.gruppen product requires repair, contact your Lab.gruppen dealer or distributor, visit http://labgruppen.com/support/find_service_centre/ or contact Lab.gruppen by phone or email to obtain details for the nearest authorized service center.

16.2.2. Factory service

In the event a Lab.gruppen product requires factory service, you may contact Lab.gruppen's service department for return instructions and a Return Authorization number.

Please note for product return:

1. Use the original packing.
2. Include a copy of the sales receipt, your name, return address, phone and fax number, email address and description of the defect.
3. Mark the Return Authorization number on the outside of the packing.

Ship the product prepaid to:

Lab.gruppen AB Faktorvägen 1
SE-434 37 Kungsbacka
Sweden
Phone: +46 300 56 28 00
Fax: +46 300 56 28 99

service@labgruppen.com www.labgruppen.com

Notes

Notes

labgruppen.com

Lab.gruppen adopts a policy of continuous improvement and product specification is subject to change.
RPM, R.SMPS, PFC, CDM, BEL, UVL, CAFÉ, ESP, ISVPL, Iso-Float, Raised Cosine, MESA EQ, LimiterMax and
LoadLibrary are trademarks of Lab.gruppen AB. All other trademarks remain the property of their respective owners.
Copyright © 2015 Lab.gruppen AB. All rights reserved.